



WORKFORCE OF
6,000+ DEDICATED EMPLOYEES
WITH 500+ ENGINEERS IN R&D



AMONG TOP 5 TRACTOR
MANUFACTURERS
GLOBALLY



NO. 1
TRACTOR EXPORTER
FROM INDIA



SOLD IN
150+ COUNTRIES
WORLDWIDE

Solis

INTERNATIONAL TRACTORS USA CORPORATION

Headquarter - 1900 Parrish Dr. SE, Rome, Georgia 30161

Office Phone No.: (706) 784-4349

Email - sales@solistractors.com | Phone no.+1 (514) 850-9580 | Website: www.solistractorusa.com



SCAN ME



Solis



Tough. Rugged. Value

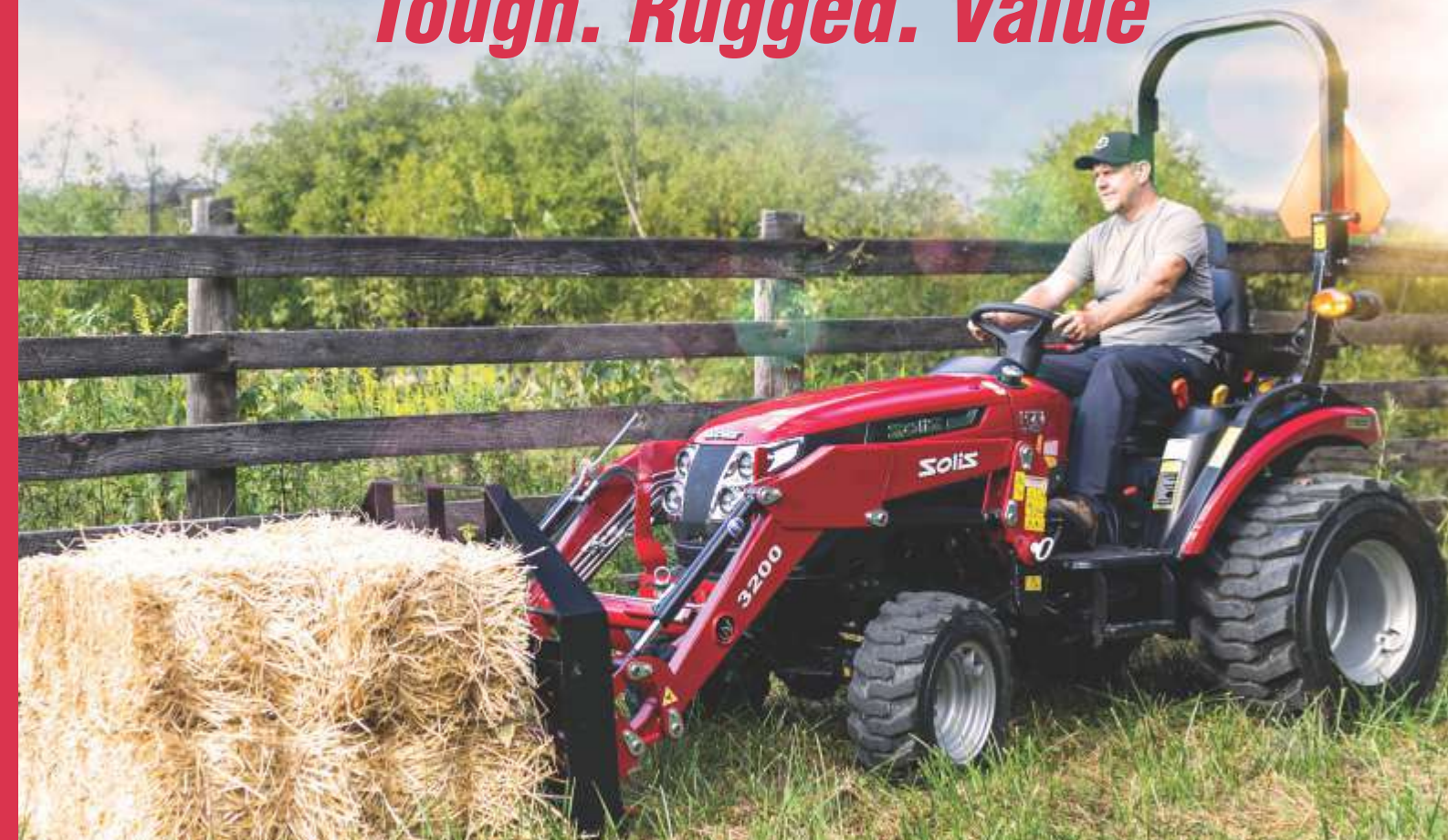

COMPACT TRACTOR RANGE



www.solistractorusa.com



WORLD'S NO.1 INTEGRATED MANUFACTURING PLANT



ROBOTIC PAINTSHOP



ROBOTIC GEAR SHOP



ROBOTIC WELDING



Solis brand tractors are manufactured in the world's largest vertically integrated tractor factory in Hoshiapur, Punjab, India, where nearly all components are made on site across 10 subsystem manufacturing centers. Annual production capacity exceeds 300,000 tractors, with a daily output of over 1,000 units. International Standards Organization

(ISO) certified for manufacturing and engineering process, Solis brand tractors are designed and produced to the highest industry standards, with a primary focus on quality and productivity to ensure customer satisfaction throughout operations and ownership.



Tough. Rugged. Value

SOLIS IS SOLD IN

150+ COUNTRIES

SOLIS IS THE MARKET LEADER IN

15+ COUNTRIES*



AMONG TOP 5
WORLD'S LARGEST TRACTOR
MANUFACTURERS
(by volume)

MORE THAN 1.5 MILLION

SATISFIED CUSTOMERS WORLDWIDE

SOLIS COMPACT TRACTOR RANGE



H24+	
HP Category	24HP
Weight (LBS)	2530
Loader Lift Capacity (LBS)	1411

H24 HYDROSTATIC	
HP Category	24HP
Weight (LBS)	2513
Loader Lift Capacity (LBS)	1411

H24 HYDROSTATIC WITH HEAT CABIN	
HP Category	24HP
Weight (LBS)	3108
Loader Lift Capacity (LBS)	1411

S24 SHUTTLE DRIVE (9+9)	
HP Category	24HP
Weight (LBS)	2513
Loader Lift Capacity (LBS)	1411

S24 GEAR DRIVE (6+2)	
HP Category	24HP
Weight (LBS)	2292.80
Loader Lift Capacity (LBS)	1411



SIDE MIRRORS



TOOL BOX



FLOOR MAT



HIGH ENG TORQUE
3 CYLINDER MHI ENGINE



INTEGRATED JOYSTICK



CRUISE CONTROL &
ELECTRO-HYDRAULIC PTO



SEAT WITH THE
HEADREST



R14 BIGGER TIRES



MECHANICAL SELF
LEVEL LOADER

ALL STANDARD FEATURES



HYDROSTATIC TRANSMISSION
WITH TWIN HST PEDAL



STANDARD MID PTO



STANDARD
REAR REMOTES

H24+
= HST



SPECIFICATIONS

FEATURES		H24+ = HST
ENGINE		
Engine Model	3 Cylinder Mitsubishi Engine	
HP Category	24	
No. of Cylinder	3	
Aspiration	Natural	
Cubic Capacity (Ci)	80.42	
Rated RPM	2500	
Max Torque	76.3Nm@2000	
TRANSMISSION		
Drive	4WD	
Forward/Reverse Controls	Twin Touch Pedals	
Gearbox	HST (2 Range)	
Transmission Type	Constant Mesh	
Cruise Control	Yes	
BRAKES		
Type	Oil Immersed Brakes	
Type of Actuation	Mechanical, Foot Operated	
Differential Lock	Standard	
PTO		
PTO (RPM)	Rear - 540@2451 Mid PTO - 2100@2438	
PTO Clutch	Wet Type	
PTO Actuation	Button Operated	
Steering	Power Steering	
HYDRAULICS		
3 Point Linkages	CAT1N	
3 Point Lifting Capacity@ball ends (lbs)	1323	
Aux Hydraulic Circuit	1DA (Detent with Float)	
Total Hydraulic Flow (GPM)	3.98	
CAPACITY		
Fuel Tank (Gal)	7	
DIMENSIONS & WEIGHT (R 14 Tires)		
Weight (lbs)	2530	
Wheel Base (in)	61.8	
Total Length with TPL (in)	114.40	
Total Width (in)	54.0	
Height (in) upto ROPS	92.7	
Ground Clearance	10.61 (Front Axle)	



FEATURES		H24+ = HST
TIRES		
R14 (Standard)	25x8.50-14 R14T & 14-17.5 R14T	
Industrial	23x8.50-12 & 33x15.5-16.5	
Turf	23x8.50-12 & 33x15.5-16.5	
Turf	25x8.50-14 & 13.6x16	
Agri	6x12 & 8.3x20	
Radial	6.5/80-12 & 280/70R18	
Galaxy Pro	220/55 R12 & 280/70 R16	

LOADER TECHNICAL SPECIFICATION

Loader Model	HB24
MSL	MSL
Max Lifting Height at Pivot Point (in)	85
Clearance with Attachment Dump (in)	58
Reach at Maximum Height (in)	17
Reach at Bucket on Ground (in)	56
Max. Dump Angle (Deg.)	45
Attachment Rollback Angle (Deg.)	43
Digging Depth Below Grade (in)	5.9
Breakout Force at Pivot Point (Dig Position) (lbs)	1146
Bucket Width (in)	60
Lifting Capacity to Full Height at Pivot Point (lbs)	1411

*Data and specifications are subject to change without any advance notice due to continuous product improvement and development. All dimensions are with standard tires.

*Limited time period offer.

Prices & offer are subject to change without any prior information.

H24

24HP (Hydrostatic)



Our "All Day Comfort Seat" will allow you to work on long days, and ensure you remain comfortable even during your toughest jobs.

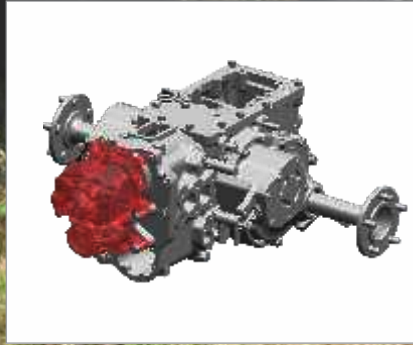

Our clutchless Hydrostatic Transmission allows for easy operation, and is designed to provide the optimal speed suited to your task.



Our control levers are strategically placed for easy access, on both our right and left consoles. Further, our switches are conveniently located near our instrument panel.

H24

24HP (Hydrostatic)

WIDE OPERATOR PLATFORM

Our wide operator platform, adjustable seat, and large flat deck ensure enhanced comfort while operating the tractor.

The wide space between the fenders also makes you more comfortable while working.



H24 - POWER AND COMFORTS

Our Compact Series is the ultimate solution for the job, offering so many Accessories to help you get your job finished.

SPECIAL UTILITY MODEL FEATURES

- Flat Operator Platform
- Deluxe Seat
- Integrated Loader Joystick
- Cup Holder
- Floor Mat
- Mid-PTO
- Cruise Control
- Footstep at Both Sides

H24
24HP (Hydrostatic)

OPEN STATION TRACTOR



SEAT WITH ARM REST
& HEAD REST



CRUISE CONTROL



INTEGRATED LOADER
JOYSTICK



FLOOR MAT



LOADER LEVELLER



MID PTO



REAR SWING DRAWBAR



HYDRAULIC REAR REMOTES

ALL STANDARD FEATURES



PROJECTOR HEADLAMPS



FRONT TOW HOOK

H24

24HP (Hydrostatic)



SPECIFICATIONS

FEATURES	H24
ENGINE	
Engine Model	Mitsubishi S3L2
HP Category	24
No. of Cylinder	3
Aspiration	Natural
Cubic Capacity (Ci)	80.42
Rated RPM	2500
Max Torque	76.3Nm @ 2000
TRANSMISSION	
Drive	4WD
Forward/Reverse Controls	Twin Touch Pedals
Gearbox	HST (2 Range)
Transmission Type	Constant Mesh
Cruise Control	Yes
BRAKES	
Type	Oil Immersed Brakes
Type of Actuation	Mechanical, Foot Operated
Differential Lock	Standard
PTO	
PTO (RPM)	Rear - 540 @ 2451 Mid PTO - 2100 @ 2438
PTO Clutch	Wet Type
PTO Actuation	Button Operated
Steering	Power Steering
HYDRAULICS	
3 Point Linkages	CAT-1N
3 Point Lifting Capacity @ ball ends (lbs)	1323
Aux Hydraulic Circuit	1DA (Detent with Float)
Total Hydraulic Flow (GPM)	3.98
CAPACITY	
Fuel Tank (Gal)	7
DIMENSIONS & WEIGHT (AGRI TIRES)	
Weight (lbs)	2513
Wheel Base (in)	61.8
Total Length with TPL (in)	113.98
Total Width (in)	47.83
Height (in) upto ROPS	91.53
Ground Clearance	9.44 (Front Axle)



FEATURES	H24
TIRES	
Industrial	23x8.50-12 & 33x15.5-16.5
Turf 1	23x8.50-12 & 33x15.5-16.5
Turf 2	25x8.50-14 & 13.6x16
Agri 1	6x12 & 8.3x20
Agri 2	7x14 & 8.3x24
Radial Agri	6.5/80-12 & 280/70R18
Galaxy Pro	220/55 R12 & 280/70 R16
R14	25x8.50-14 & 14-17.5

LOADER TECHNICAL SPECIFICATION

Loader Model	HLN24	HBLN24	HB24
NSL/MSL	NSL	NSL	MSL
Max Lifting Height at Pivot Point (in)	82	85	85
Clearance with Attachment Dump (in)	61	61	58
Reach at Maximum Height (in)	33	17	17
Reach at Bucket on Ground (in)	63	56	56
Max. Dump Angle (Deg.)	44	45	45
Attachment Rollback Angle (Deg.)	31	43	43
Digging Depth Below Grade (in)	2.5	5.9	5.9
Breakout Force at Pivot Point (Dig Position) (lbs)	1565	1058	1146
Bucket Width (in)	48	52	60
Lifting Capacity to Full Height at Pivot Point (lbs)	1500	926	1411
3rd function	Optional	Optional	Optional

*Data and specifications are subject to change without any advance notice due to continuous product improvement and development. All dimensions are with standard tires.

H24

HEAT CABIN
24HP (Hydrostatic)

COMFORT





STANDARD EQUIPMENT FOR CABIN

- Heat Cabin
- Wide Operator Platform
- Mid & Rear PTO
- 2-Stage Opening Rear Window
- Cab Interior Light
- Cruise Control
- Radio Ready
- Front and Rear LED Work Lights
- Side Mirrors
- Deluxe Suspension Seat
- Front & Rear Wiper
- Floor Mat
- Cup Holder
- Integrated Loader Joystick



SPACIOUS & COMFORTABLE CABIN

The Compact Series delivers incredible comfort for the operator, courtesy of our new integrated cab. The Four Pillar design gives you extra space and a great view of your work area. Our door entry is broad, allowing ease of entrance and exit.

STYLISH PROJECTOR HEAD LIGHTS

Our stylish EPA compliant projector head lamps project a high intensity, focused, wide spread beam. As a result, you may comfortably continue your work until well after dark.



COMFORT

Our large cab provides you a panoramic view. Our ergonomically placed levers are designed to enhance your user experience and ease operations, all with the goal of making it more efficient and productive for you.

H24

HEAT CABIN
24HP (Hydrostatic)



HEAT CABIN



CRUISE CONTROL



INTEGRATED LOADER
JOYSTICK



FLOOR MAT

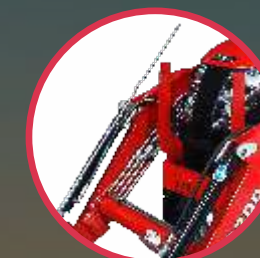

LOADER LEVELLER



MID PTO



REAR SWING DRAWBAR



HYDRAULIC REAR REMOTES

ALL STANDARD FEATURES



PROJECTOR HEADLAMPS



FRONT TOW HOOK

H24

HEAT CABIN
24HP (Hydrostatic)



SPECIFICATIONS

FEATURES	H24 HEAT CABIN
ENGINE	
Engine Model	Mitsubishi S3L2
HP Category	24
No. of Cylinder	3
Aspiration	Natural
Cubic Capacity (Ci)	80
Rated RPM	2500
Max Torque	76Nm@2000
TRANSMISSION	
Drive	4WD
Forward/Reverse Controls	Twin Touch Pedals
Gearbox	HST (2 Range)
Transmission Type	Constant Mesh
Cruise Control	Yes
BRAKES	
Type	Oil Immersed Brakes
Type of Actuation	Mechanical, Foot Operated
Differential Lock	Standard
PTO	
PTO (RPM)	Rear - 540 @ 2451 Mid PTO - 2100 @ 2438
PTO Clutch	Wet Type
PTO Actuation	Button Operated
Steering	Power Steering
HYDRAULICS	
3 Point Linkages	CAT-1N
3 Point Lifting Capacity @ ball ends (lbs)	1323
Aux Hydraulic Circuit	1DA (Detent with Float)
Total Hydraulic Flow (GPM)	3
CAPACITY	
Fuel Tank (Gal)	7
DIMENSIONS & WEIGHT (AGRI TIRES)	
Weight (lbs)	3108
Wheel Base (in)	61
Total Length with TPL (in)	112
Total Width (in)	47
Height (in) upto ROPS	93
Ground Clearance	9 (Front Axle)



FEATURES	H24 HEAT CABIN
TIRES	
Industrial	23x8.50-12 & 33x15.5-16.5
Turf 1	23x8.50-12 & 33x15.5-16.5
Turf 2	25x8.50-14 & 13.6x16
Agri	6x12 & 8.3x20
Radial Agri	6.5/80-12 & 280/70R18
Galaxy Pro	220/55 R12 & 280/70 R16
R14	23x8.50-12 R14T & 12-16.5 R14T
R14	25x8.50-14 & 14-17.5

LOADER TECHNICAL SPECIFICATION

Loader Model	HLN24	HB24
NSL/MSL	NSL	MSL
Max Lifting Height at Pivot Point (in)	82	85
Clearance with Attachment Dump (in)	61	58
Reach at Maximum Height (in)	33	17
Reach at Bucket on Ground (in)	63	56
Max. Dump Angle (Deg.)	44	45
Attachment Rollback Angle (Deg.)	31	43
Digging Depth Below Grade (in)	2.5	5.9
Breakout Force at Pivot Point (Dig Position) (lbs)	1565	1146
Bucket Width (in)	48	60
Lifting Capacity to Full Height at Pivot Point (lbs)	1500	1411
3rd function	Optional	Optional

*Data and specifications are subject to change without any advance notice due to continuous product improvement and development. All dimensions are with standard tires.

S24 (9F+9R)
SHUTTLE XL 24HP (SHUTTLE DRIVE)



S24 (9F+9R)
SHUTTLE XL 24HP (SHUTTLE DRIVE)

VERSATILE PERFORMER



**SEAT WITH ARM REST
AND HEAD REST**



**SHUTTLE
(FORWARD/REVERSE)**



FLOOR MAT



LOADER LEVELLER



**9F + 9R SPEEDS
TRANSMISSION**



REAR SWING DRAWBAR



HYDRAULIC REAR REMOTES

ALL STANDARD FEATURES



PROJECTOR HEADLAMPS



100% METAL HOOD



FRONT TOW HOOK



S 24 (9F+9R)
SHUTTLE XL 24HP (SHUTTLE DRIVE)

WIDE OPERATOR PLATFORM

Our wide operator platform, adjustable seat, and large flat deck ensure enhanced comfort while operating the tractor.

The wide space between the fenders also makes you more comfortable while working.



S 24 XL - POWER AND COMFORTS

Our Compact Series is the ultimate solution for the job, offering so many accessories to help you get your job finished.

SPECIAL UTILITY MODEL FEATURES

- Flat Operator Platform
- Deluxe Seat
- Cup Holder
- Floor Mat
- 9F+9R Transmission
- Footstep at Both Sides

24 (9F+9R)

SHUTTLE XL 24HP (SHUTTLE DRIVE)



SPECIFICATIONS

FEATURES	24 Shuttle XL
ENGINE	
Engine Model	Mitsubishi S3L2
HP Category	24
No. of Cylinder	3
Aspiration	Natural
Cubic Capacity (Ci)	80.42
Rated RPM	2500
Torque	76.3 Nm @ 2000
TRANSMISSION	
Drive	4WD
Forward/Reverse Lever	Synchromesh Shuttle Lever on Dashboard
Gearbox	9+9
Transmission Type	Constant Mesh with Synchromesh Shuttle Transmission
Cruise Control	Yes
BRAKES	
Type	Oil Immersed Brakes
Type of Actuation	Mechanical, Foot Operated
Differential Lock	Standard
PTO	
PTO (RPM)	540/540E
PTO Actuation	Mechanical
Steering	Power Steering
HYDRAULICS	
3 Point Linkages	CAT-1N
3 Point Lifting Capacity @ ball ends (lbs)	1323
Aux Hydraulic Circuit	1DA (Detent with Float)
Total Hydraulic Flow (GPM)	6.5
CAPACITY	
Fuel Tank (Gal)	5.8
DIMENSIONS & WEIGHT (AGRI TIRES)	
Weight (lbs)	2513
Wheel Base (in)	61.8
Total Length (in)	113.98
Total Width (in)	47.83
Height (in) upto ROPS	91.53
Ground Clearance	9.44 (Front Axle)

*Data and specifications are subject to change without any advance notice due to continuous product improvement and development. All dimensions are with standard tires.



FEATURES	24 Shuttle XL
TIRES	
Industrial	23x8.50-12 & 33x15.5-16.5
Turf 1	23x8.50-12 & 33x15.5-16.5
Turf 2	25x8.50-14 & 13.6x16
Agri 1	6x12 & 8.3x20
Agri 2	7x14 & 8.3x24
Radial Agri	6.5/80-12 & 280/70 R18
Galaxy Pro	220/55 R12 & 280/70 R16

LOADER	TECHNICAL SPECIFICATION
Loader Model	XB24
NSL/MSL	MSL
Max Lifting Height at Pivot Point (in)	85
Clearance with Attachment Dump (in)	58
Reach at Maximum Height (in)	17
Reach at Bucket on Ground (in)	56
Max. Dump Angle (Deg.)	45
Attachment Rollback Angle (Deg.)	43
Digging Depth Below Grade (in)	5.9
Breakout Force at Pivot Point (Dig Position) (lbs)	1146
Bucket Width (in)	60
Lifting Capacity to Full Height at Pivot Point (lbs)	1411
3rd function	Optional

S24 (6F+2R)
24HP (Manual Drive)

VERSATILE PERFORMER



TOOL BOX



FLOOR MAT



HEAVY DUTY FRONT AXLE



LOADER LEVELLER



GRAB RAILS



HEAVY DUTY FRONT LOADER



REAR SWING DRAWBAR

ALL STANDARD FEATURES



PROJECTOR HEADLAMPS



HYDRAULIC REAR REMOTES



FRONT TOW HOOK

S24 (6F+2R)

24HP (Manual Drive)



SPECIFICATIONS

FEATURES	S24
ENGINE	
Engine Model	Mitsubishi S3L2
HP Category	24
No. of Cylinder	3
Aspiration	Natural
Cubic Capacity (Ci)	80.42
Rated RPM	2500
Torque	76.2 Nm @ 2000
TRANSMISSION	
Drive	4WD
Clutch	Single
Gearbox	6F+2R
BRAKES	
Type	Oil Immersed Brakes
Type of Actuation	Mechanical, Foot Operated
Differential Lock	Standard
PTO	
PTO (RPM)	540 @ 2491
PTO Actuation	Mechanical
Steering	Power Steering
HYDRAULICS	
3 Point Linkages	CAT-1N
3 Point Lifting Capacity @ ball ends (lbs)	1323
Aux Hydraulic Circuit	1DA
Total Hydraulic Flow (GPM)	3.27 GPM
CAPACITY	
Fuel Tank (Gal)	7
DIMENSIONS & WEIGHT (AGRI TIRES)	
Weight (lbs)	2292
Wheel Base (in)	61.4
Total Length (in)	108.66
Total Width (in)	42.32
Height (in) upto ROPS	84.34
Ground Clearance	9.44 (Front Axle)



FEATURES	S24
TIRES	
Industrial	23x8.50-12 & 33x15.5-16.5
Turf	23x8.50-12 & 33x15.5-16.5
Agri 1	6x12 & 8.3x20
Agri 2	7x14 & 8.3x24
Radial Agri	6.5/80-12 & 280/70 R18
Galaxy Pro	220/55 R12 & 280/70 R16

LOADER TECHNICAL SPECIFICATION

Loader Model	SB24
NSL/MSL	NSL/MSL
Max Lifting Height at Pivot Point (in)	85
Clearance with Attachment Dump (in)	58
Reach at Maximum Height (in)	17
Reach at Bucket on Ground (in)	56
Max. Dump Angle (Deg.)	45
Attachment Rollback Angle (Deg.)	43
Digging Depth Below Grade (in)	5.9
Breakout Force at Pivot Point (Dig Position) (lbs)	1146
Bucket Width (in)	52
Lifting Capacity to Full Height at Pivot Point (lbs)	1411
3rd function	Optional

*Data and specifications are subject to change without any advance notice due to continuous product improvement and development. All dimensions are with standard tires.

SOLIS LOADER ATTACHMENT ADD-ONS (SKID STEER QUICK ATTACH)



60 Inch Bucket

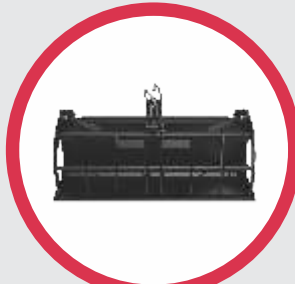

47 Inch Grabber



47 Inch Grapple



60 Inch Multi-Purpose 4-in-1

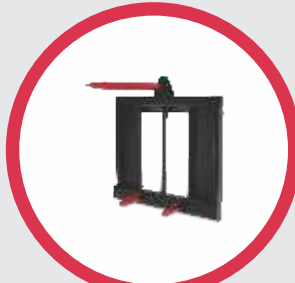

Bale Spike



Pallet Fork



3rd Function Kit

SOLIS LOADER ATTACHMENT ADD-ONS (SKID STEER QUICK ATTACH) SPECIFICATION

BUCKET TYPE	STD BUCKET 1.5M SKIDSTEER HITCH	STD BUCKET 1.35M
SERIES	2000	2000
HP Range	15-24	15-24
Struck Capacity (cu Yd)	0.22	0.20
Heaped Capacity (cu Yd)	0.26	0.22
Dimensions LxWxH (inches)	61x19x20	55x20.1x20
Weight (lbs)	182.6	150.7
Working Depth (inches)	4.2	4.2
Side Wall Thickness (inches)	0.1	0.2
Cutting Edge Thickness (inches)	0.5	0.5

BUCKET TYPE	GRABBER BUCKET SKID STEER HITCH 1.35M
SERIES	2000
HP Range	15-24
Struck Capacity (cu yd)	0.16
Heaped Capacity (cu yd)	0.22
Dimensions LxWxH (inches)	53.6x21x24.8
Weight (lbs)	279
Grabber Opening Height (inches)	23.6
Number of Tines (Non Removable)	8
Tine Thickness (inches)	0.3
Number of Hydraulic Cylinder	1
Maximum Hydraulic Pressure (psi)	2610

BUCKET TYPE	GRAPPLE BUCKET 1.4 M SKID STEER HITCH
SERIES	2000
HP Range	15-24
Struck Capacity (cu Yd)	0.13
Heaped Capacity (cu Yd)	0.22
Dimensions LxWxH (inches)	56x20x25
Weight (lbs)	296
Grapple Opening Height (inches)	34.8
Number of Tines (non removable)	5
Tine Thickness (inches)	0.2
Number of Hydraulic Cylinder	2
Maximum Hydraulic Pressure (psi)	2610

BUCKET TYPE	4 IN 1 BUCKET 1.5M SKID STEER HITCH
SERIES	2000
HP Range	15-24
Struck Capacity (cu Yd)	0.24
Heaped Capacity (cu Yd)	0.27
Dimensions LxWxH (inches)	60x22.2x21.7
Weight (lbs)	277
Maximum Hydraulic Pressure (psi)	2610
Number of Hydraulic Cylinder	2
Clamshell Opening Angle (degree)	90

BUCKET TYPE	BALE SPIKE
SERIES	2000
HP Range	15-24
Lift Capacity (lbs)	660
Dimensions LxWxH (inches)	47.5x43x25
Weight (lbs)	202
Usable Spear Length (Big) (inches)	43.3
Usable Spear Length (Small) (inches)	27
No of Spears	3

BUCKET TYPE	PALLET FORK SKID STEER HITCH
SERIES	2000
HP Range	15-24
Lift Capacity (lbs)	660
Dimensions LxWxH (inches)	45x30.5x25.7
Weight (lbs)	200
Tine Thickness (inches)	0.2
Tine Length (inches)	28
Tine Width (inches)	4
Tine Height (inches)	2

BACK HOE

Solis Backhoe is a versatile machine and performs exceptionally in loading, digging, backfilling & trenching applications. Its superior features like Heavy Duty Boom & Stick, Ergonomically designed operator seat & quick attach & detach with tractor makes it a perfect choice for compact & subcompact range of tractors

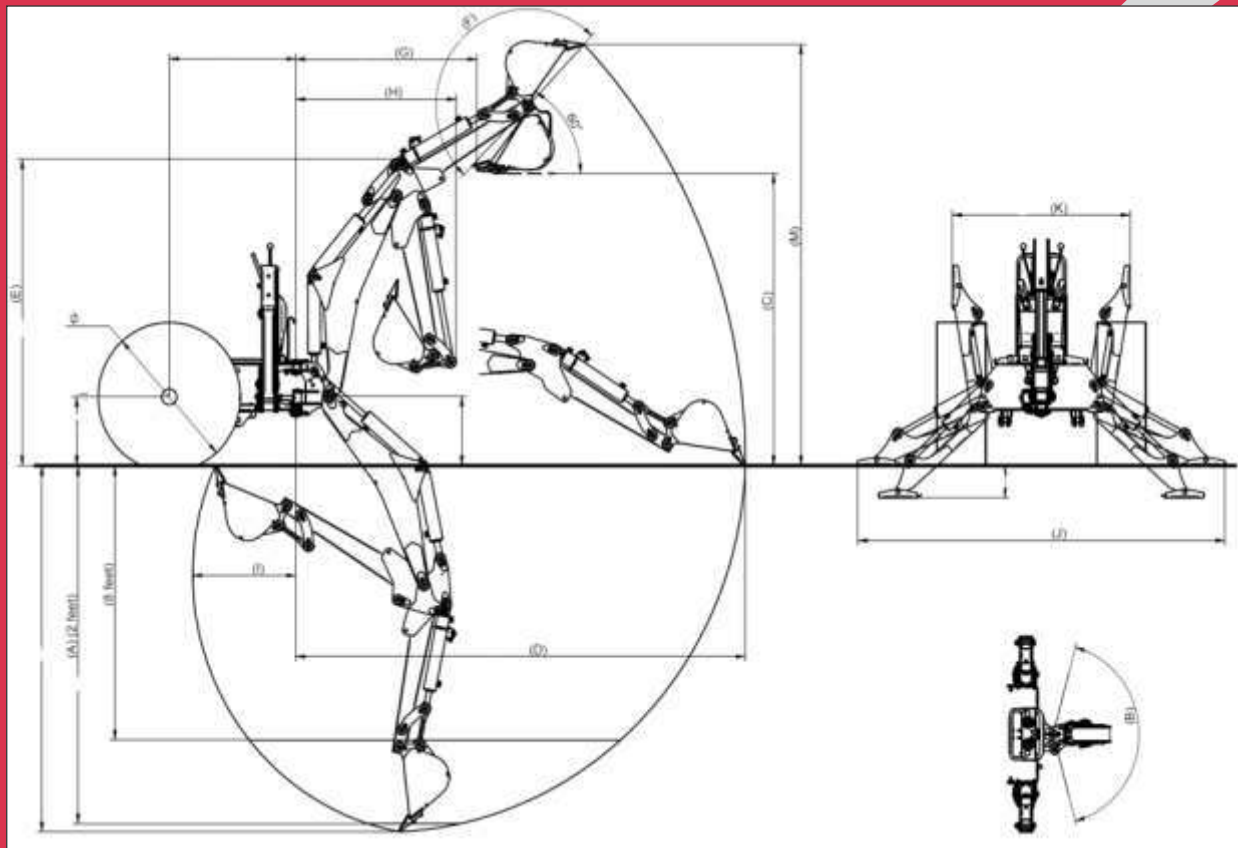

SUPERIOR PILOT OPERATED CHECK VALVE



HIGHER CAPACITY WALVOIL VALVE



ERGONOMICALLY DESIGNED OPERATOR CONSOLE



EASY TO ATTACH & DETACH WITH TRACTOR



HEAVY DUTY BOOM & STICK



EFFICIENT HYDRAULIC DISTRIBUTORS WITH PRESSURE RELIEF VALVES

i Model Name	SLBH-195
Maximum Digging Depth (inch)	76
Digging Depth (2 foot flat bottom) (A) (inch)	75
Digging Depth (8 foot flat bottom) (inch)	48
Swing Arc (B) (degree)	150
Loading Height (Bucket at 60 deg) (C) (inch)	65
Reach from Center Line of Swing Pivot (D) (inch)	107
Transport Height (maximum) (E) (inch)	71
Bucket Rotation (F) (degree)	177
Loading Reach (bucket at 60 deg) (G) (degree)	37
Undercut (I) (inch)	17
Overall Operating Height - Fully Raised (M) (inch)	104
Bucket Cylinder Digging Force (N)	13340
Dipperstick Cylinder Digging Force (N)	8990
3 Point Hitch	Cat -1
Tractor Power (HP)	20-30
Weight with Standard Bucket (lbs)	826.7
Mechanical Thumb	Standard
Bucket 14 inch	Optional
Bucket 16 inch	Optional

*Data and specifications are subject to change without any advance notice due to continuous product improvement & development

MID MOUNT MOWER (24 HST)

Definition of Effortless Mowing to Save your Moments!

Solis Mid Mount Mower, compatible to Solis 24HST Tractors is known for its unrivalled quality & performance. Its easy manoeuvrability, compact design & easy attach-detach makes it the best choice for farmers. The cutting section consists of 3 high quality cutting blades with high tips speed which increase the efficiency of mowing. The side discharge with well built chute helps in vacuum build up inside the mower & helps in even & efficient mowing.

The enhanced manoeuvrability due to presence of cutting deck in the middle of tractor helps mid mower take sharp turns easily. Solis Mid Mount Mower is best suited for terrains with more obstacles & trees.

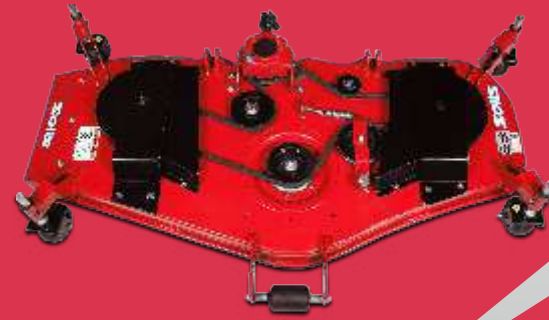

OUR DIVERSE RANGE OF ATTACHMENTS



SIDE DISCHARGE CHUTE FOR EVEN DISCHARGE AT HIGH RATE



HIGH PERFORMANCE GEARBOX



BORON STEEL BLADES WITH HIGH TIP SPEED



FRONT ROLLER TO AVOID SCALPING



EASY HEIGHT ADJUSTMENT FOR VARIABLE CUTTING HEIGHT



Box Blade



Rotary Tiller



Rotary Cutter



Finishing Mower



Flail Mower

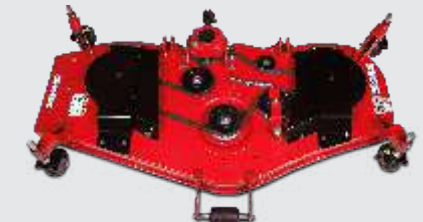

Mid Mount Mower



Round Baler























Terracer / Rear Blade



Trailers



Tandem Disc harrow

 Model Name	SLMM-60
 No. of blades	3
 Mounting method	Parallel Linkage
 Lift link type	Lower link lift
 Discharge	Side Discharge
 Cutting width (inch)	60
 Cutting height (inch)	1 to 5
 Overall Length (inch)	39.3
 Overall Height (inch)	13.4
 Overall Width (inch)	61
 Weight(lbs)	364
 Belt	Single C type Belt
 Blade Spindle speed (rpm)	2717 RPM
 Blade tip speed (fpm)	14713
 Blade length (inch)	20.7
 Number of antiscalp rollers	4+1
 Mower deck thickness (inch)	0.15
 Mower deck height (inch)	4
 Transport Height (Inch)	5
 Tractor HP required	20-26

OPTIONAL EQUIPMENT FOR SOLIS TRACTORS



3RD FUNCTION KIT



MSL LOADER OPTION



**CANOPY FOR H24 AND
S24 SHUTTLE DRIVE MODEL**

FINANCING AVAILABLE WITH



SOLIS DEALER LOCATOR

SOLIS, in collaboration with DLL, is pleased to offer dealers total financing solutions to help grow their business. From credit lines for inventory purchases to consumer financing options, DLL can help you sell more products while improving your cash flow management.

BENEFITS

\$0 DOWN
FINANCING AVAILABLE
FOR UP TO 84 MONTHS

PROGRAM DETAILS

- COMPETITIVE RATES
- QUICK CREDIT DECISIONS
- FLEXIBLE PAY BACK SCHEDULE

NO PAYMENT FOR 90 DAYS*



SCAN QR CODE
TO APPLY NOW



SCAN QR CODE TO
LOCATE YOUR DEALER